

ML-U0618SR-18C

ML-U-SR series



Drawing No. A24017

レンズ形式	Lens Type	CCTV Lens	
フォーカス位置	Focus Position	Reference Magnification	M.O.D
光学倍率	Magnification	0.019	0.050
焦点距離 (mm)	Focal Length	6.25	6.32
Fno	Fno	1.80 ~ 16.00	
使用波長域 (nm)	Wavelength range used	400 ~ 700	
NA	Numerical Aperture	-	-
WD/OD (mm)	Working/Object Distance	300.0 / 300.0	100.0 / 100.0
O/I (mm)	Object to Image Distance	394.72	194.43
鏡筒長 (mm)	Mechanical Tube Length	65.80 ~ 66.70	
レンズバック (mm)	Lens Back	11.88	12.15
被写界深度 (mm)	DOF @PCoC ϕ 0.04mm	404.810	59.732
分解能 (μ m)	Resolution @ λ =550nm	-	-
前側/後側主点位置 (mm)	Front/Rear Principal Position	31.79 / 5.55	31.79 / 5.55
入射/出射瞳位置 (mm)	Entrance/Exit Pupil Position	25.68 / -269.92	25.68 / -178.43
入射/出射瞳径 (mm)	Entrance/Exit Pupil Diameter	3.46 / 156.22	3.46 / 104.40
画角 (deg.) H×V	Angle Of View	100.32 x 83.54	99.47 x 82.63
TVディストーション (%)	TV Distortion	-2.210	-2.409
周辺光量比 (%)	Relative Illumination	23.41	30.24
質量 (g)	Weight	350.0	
マウント	Mount	C Mount	
イメージサークル径 (mm)	Image Circle	ϕ 17.6	
最大適合カメラ	Largest Compatible Camera	1.1 Inch	

ML-U0618SR-18C

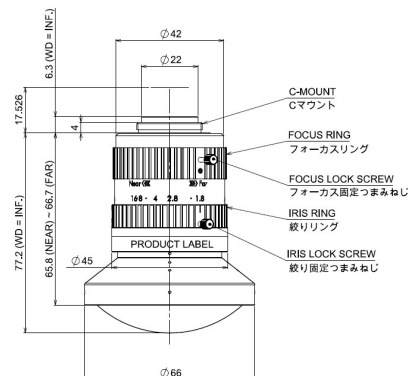

WD=300.0mm Fno1.8

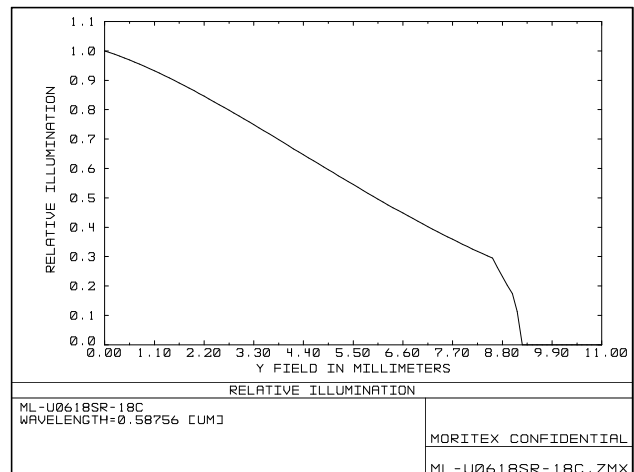
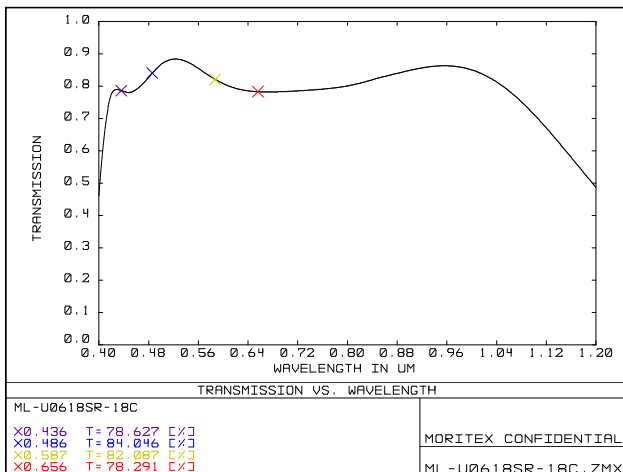
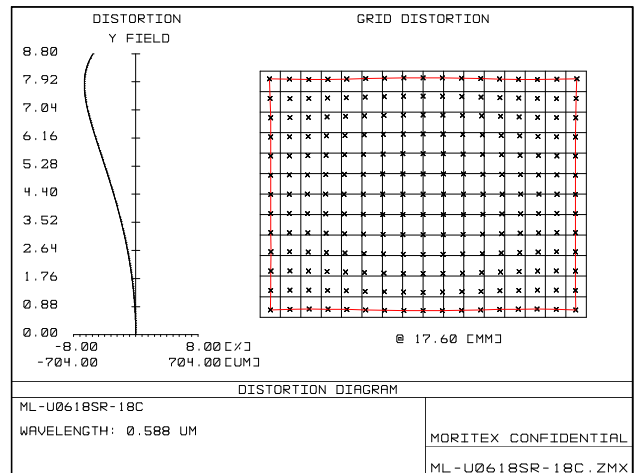
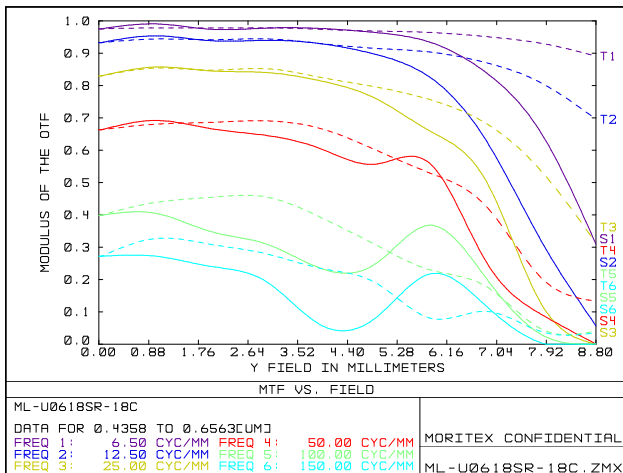

内容は、通知なしに随時変更されることがあります。

The content is subject to change at any time without notification.

株式会社 **モリテックス** MORITEX Corporation

Technology center Lens design & Development technology

moritex.mvs@moritex.com

www.moritex.com



WD=100.0mm Fno1.8

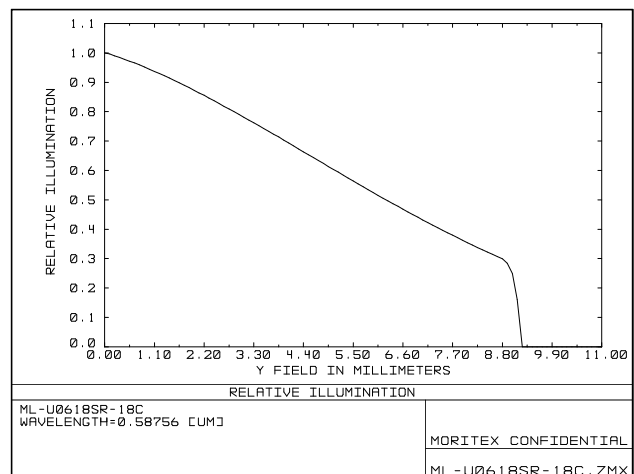
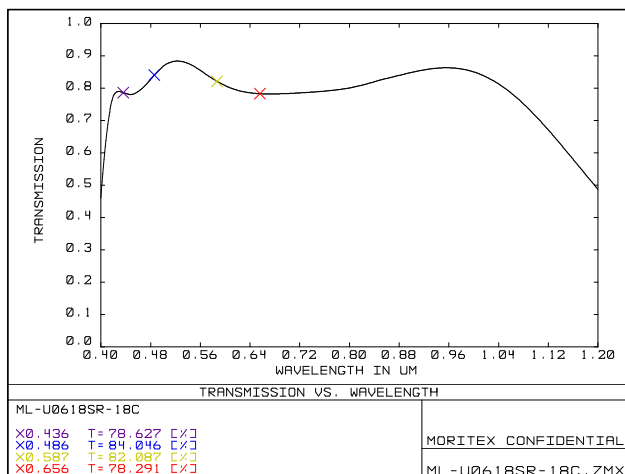
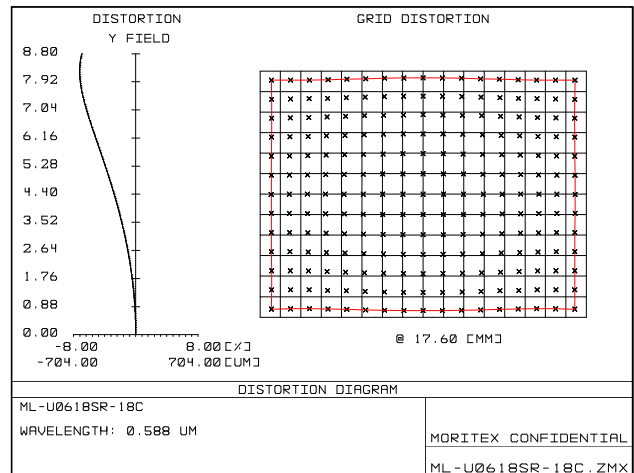
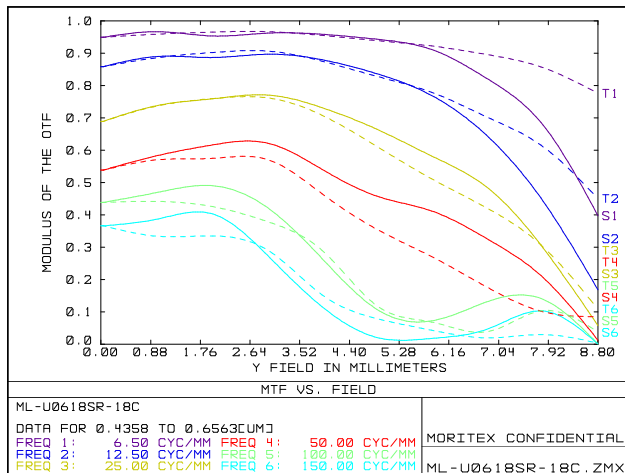

内容は、通知なしに随時変更されることがあります。

The content is subject to change at any time without notification.

株式会社 **モリテックス** MORITEX Corporation

Technology center Lens design & Development technology

moritex.mvs@moritex.com

www.moritex.com



WD=Infinity Fno1.8

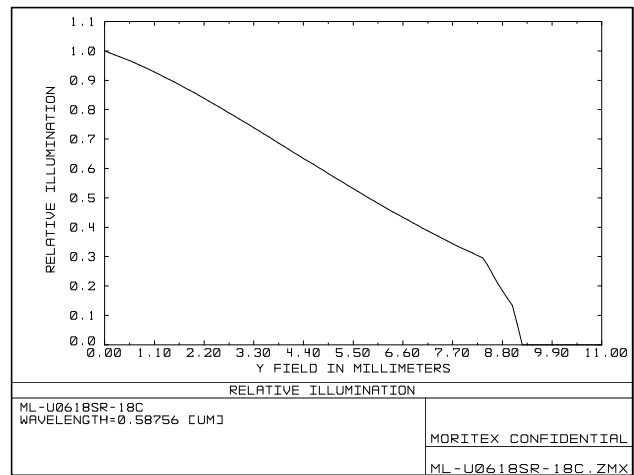
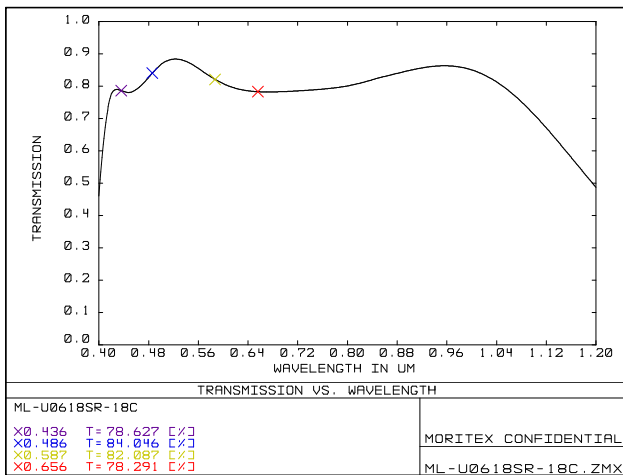
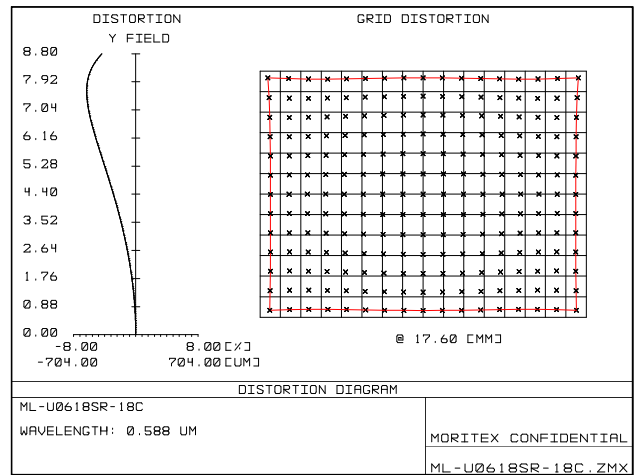
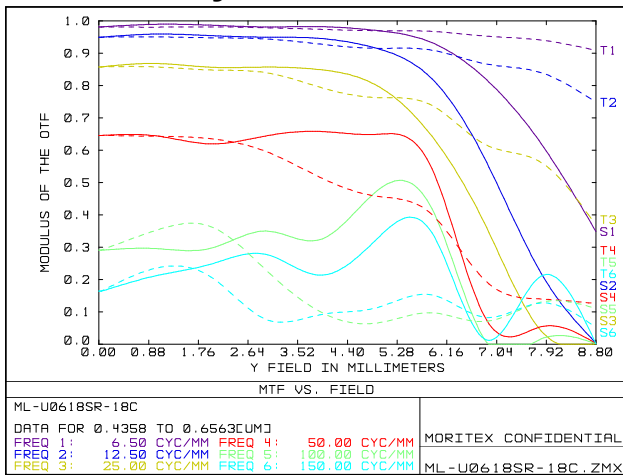

内容は、通知なしに随時変更されることがあります。

The content is subject to change at any time without notification.

株式会社 **モリテックス** MORITEX Corporation

Technology center Lens design & Development technology

moritex.mvs@moritex.com

www.moritex.com



WD=300.0mm Fno2.8

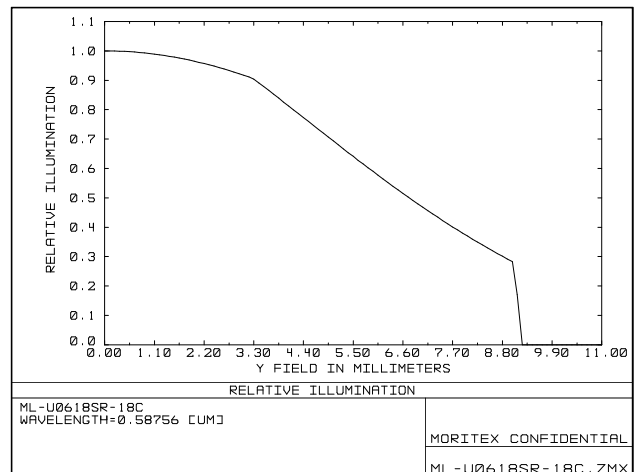
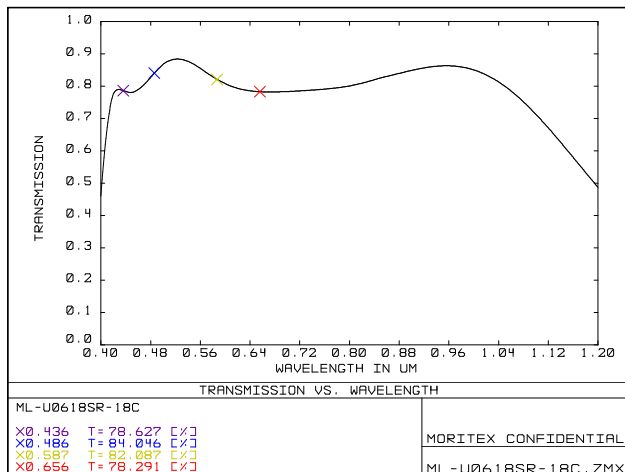
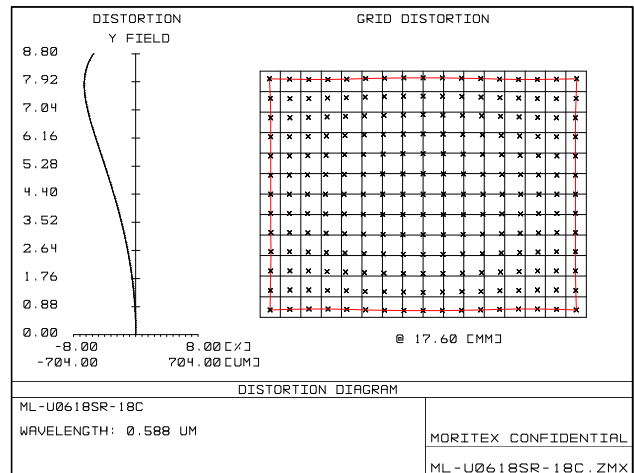
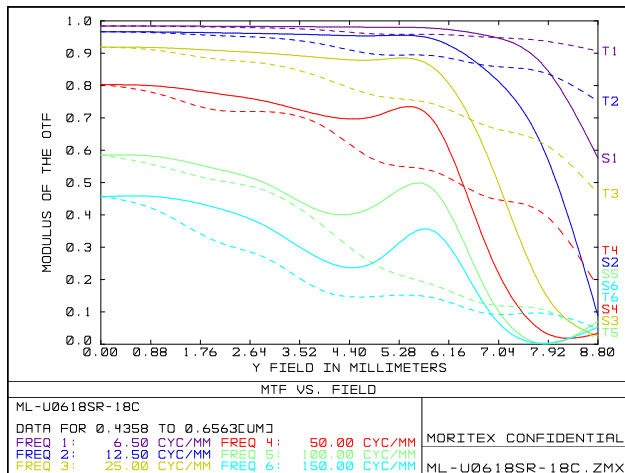

内容は、通知なしに随時変更されることがあります。

The content is subject to change at any time without notification.

株式会社 **モリテックス** MORITEX Corporation

Technology center Lens design & Development technology

moritex.mvs@moritex.com

www.moritex.com



WD=100.0mm Fno2.8

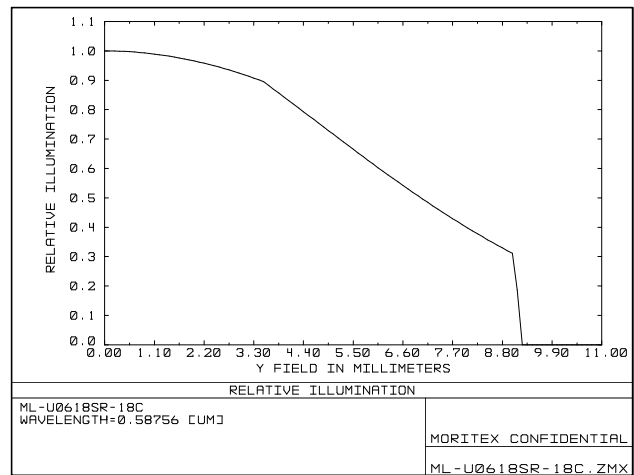
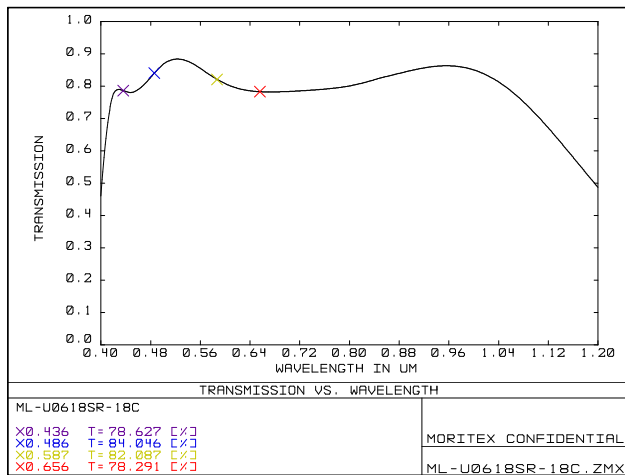
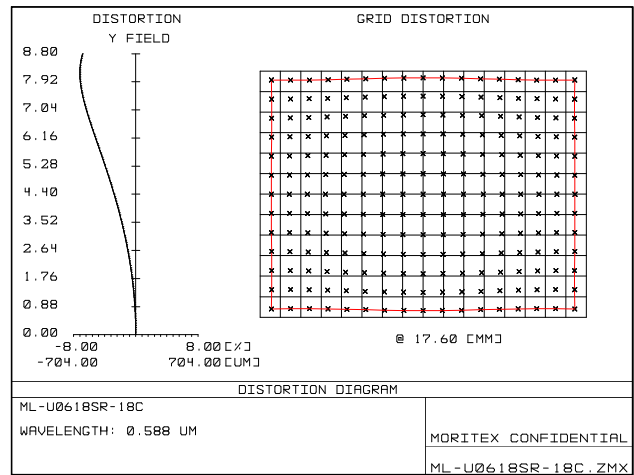
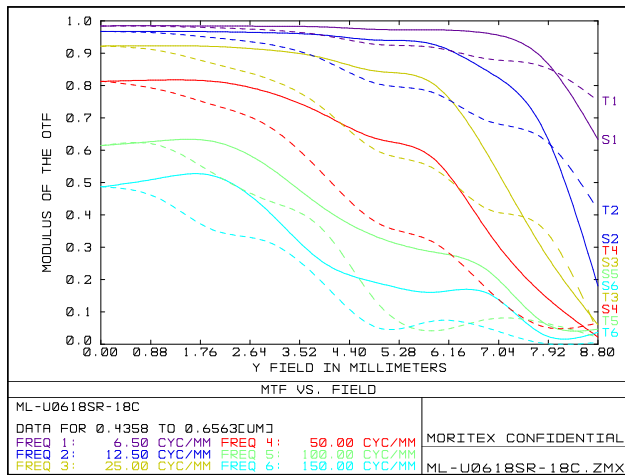

内容は、通知なしに随時変更されることがあります。

The content is subject to change at any time without notification.

株式会社 **モリテックス** MORITEX Corporation

Technology center Lens design & Development technology

moritex.mvs@moritex.com

www.moritex.com



WD=Infinity Fno2.8

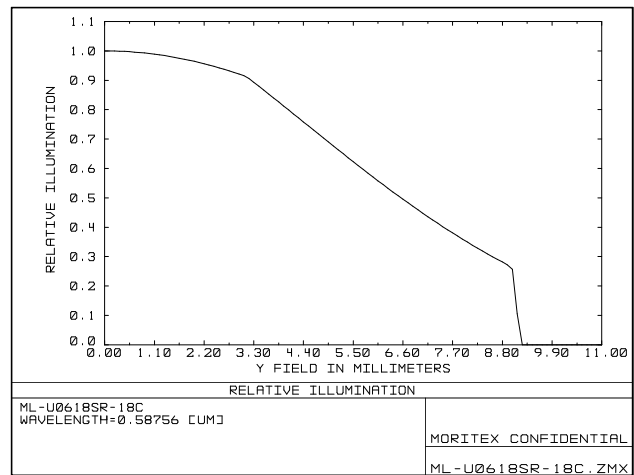
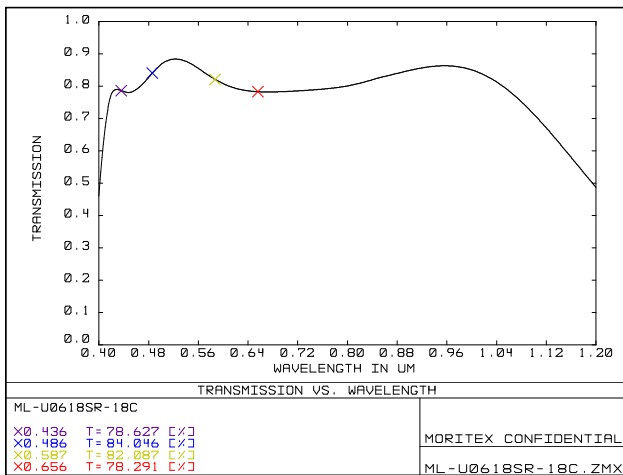
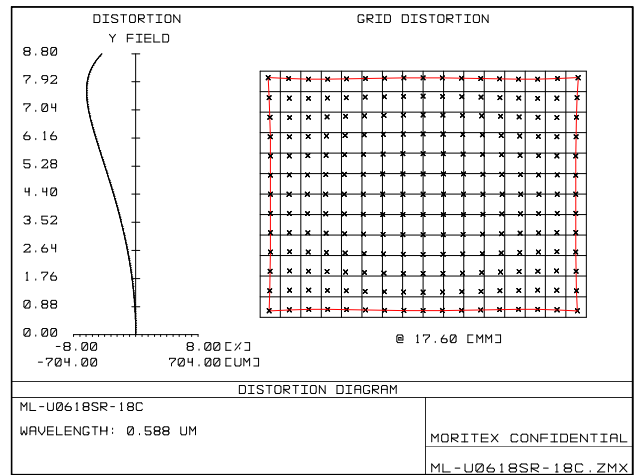
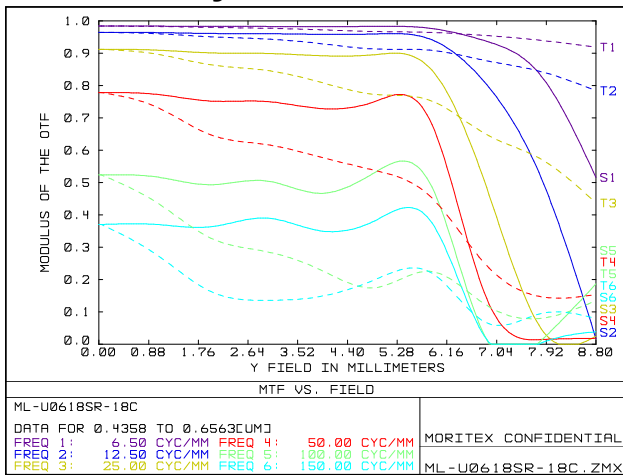

内容は、通知なしに随時変更されることがあります。

The content is subject to change at any time without notification.

株式会社 **モリテックス** MORITEX Corporation

Technology center Lens design & Development technology

moritex.mvs@moritex.com

www.moritex.com

