

ML-U3528ZR-19C

ML-U-ZR-19 series



Drawing No. A25252

レンズ形式	Lens Type	CCTV Lens	
フォーカス位置	Focus Position	Reference Magnification	M.O.D
光学倍率	Magnification	0.069	0.303
焦点距離 (mm)	Focal Length	35.18	33.57
Fno	Fno	2.80~16.00	
使用波長域 (nm)	Wavelength range used	450~850	
NA	Numerical Aperture	-	-
WD/OD (mm)	Working/Object Distance	500.0 / 503.8	100.0 / 103.8
O/I (mm)	Object to Image Distance	584.04	191.01
鏡筒長 (mm)	Mechanical Tube Length	64.50~73.40	
レンズバック (mm)	Lens Back	12.51	12.51
被写界深度 (mm)	DOF @PCoC ϕ 0.04mm	48.435	2.691
分解能 (μ m)	Resolution @ λ =550nm	-	-
前側/後側主点位置 (mm)	Front/Rear Principal Position	41.76 / -25.10	40.48 / -31.18
入射/出射瞳位置 (mm)	Entrance/Exit Pupil Position	26.08 / -53.38	26.08 / -56.40
入射/出射瞳径 (mm)	Entrance/Exit Pupil Diameter	12.49 / 22.52	12.49 / 21.87
画角 (deg.) H×V	Angle Of View	23.81 x 17.98	21.50 x 16.39
TVディストーション (%)	TV Distortion	-0.136	-0.365
周辺光量比 (%)	Relative Illumination	54.50	64.78
質量 (g)	Weight	211.0	
マウント	Mount	C Mount	
イメージサークル径 (mm)	Image Circle	ϕ 19.3	
最大適合カメラ	Largest Compatible Camera	1.2 Inch	

ML-U3528ZR-19C

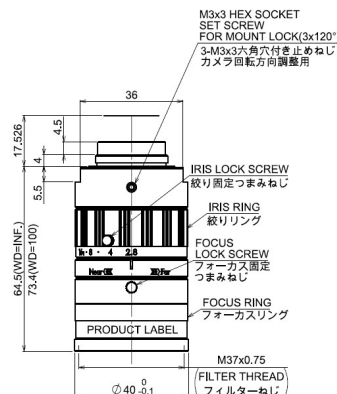

WD=500.0mm Fno2.8

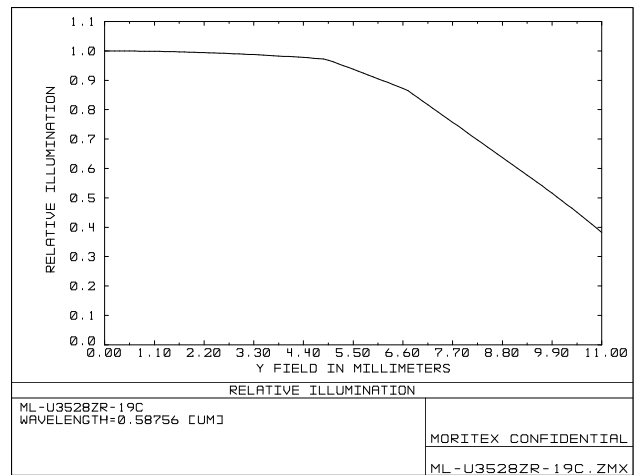
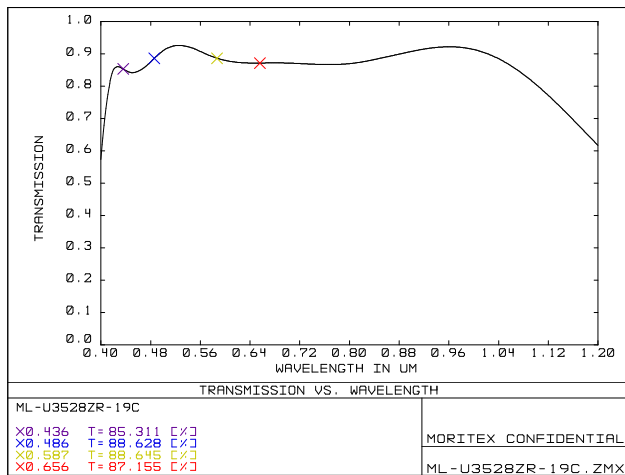
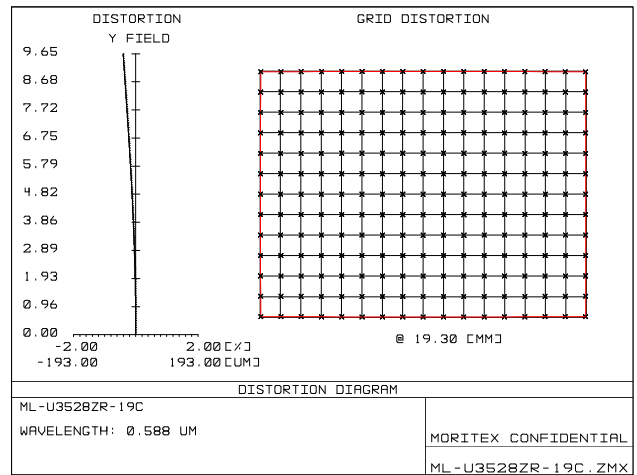
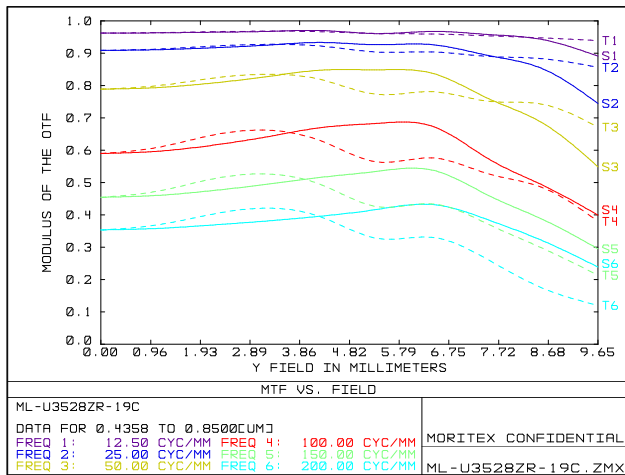

内容は、通知なしに随時変更されることがあります。

The content is subject to change at any time without notification.

株式会社 **モリテックス** MORITEX Corporation

Technology center Lens design & Development technology

moritex.mvs@moritex.com

www.moritex.com



WD=100.0mm Fno2.8

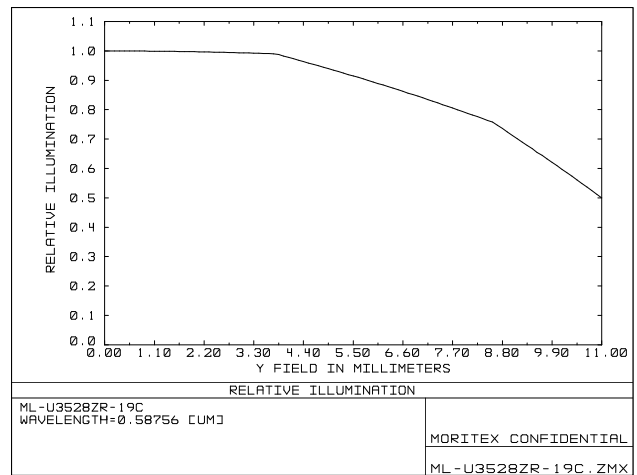
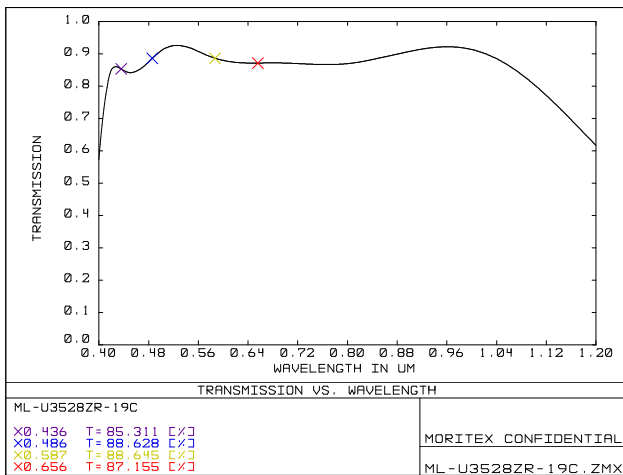
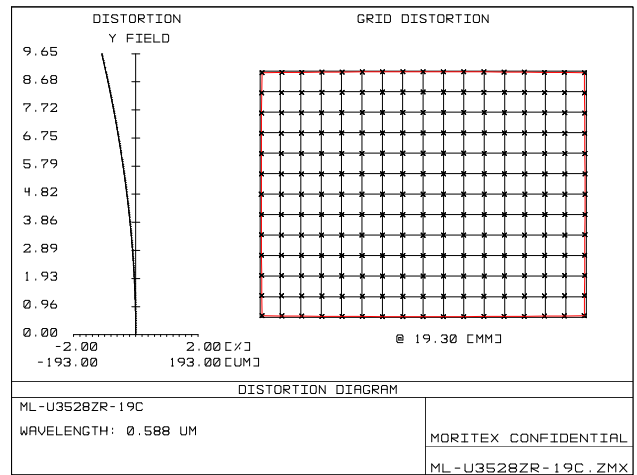
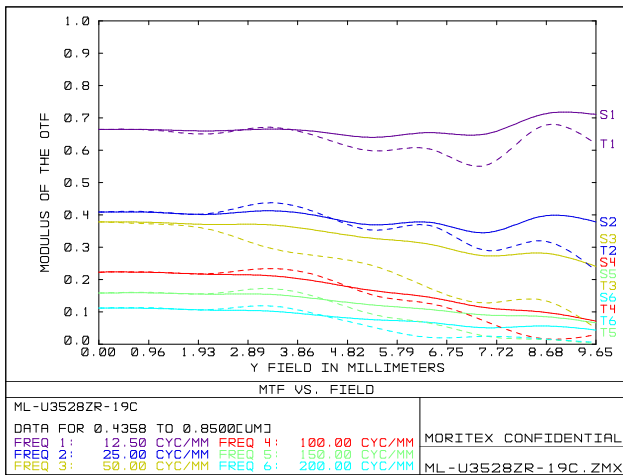

内容は、通知なしに随時変更されることがあります。

The content is subject to change at any time without notification.

株式会社 **モリテックス** MORITEX Corporation

Technology center Lens design & Development technology

moritex.mvs@moritex.com

www.moritex.com



WD=Infinity Fno2.8

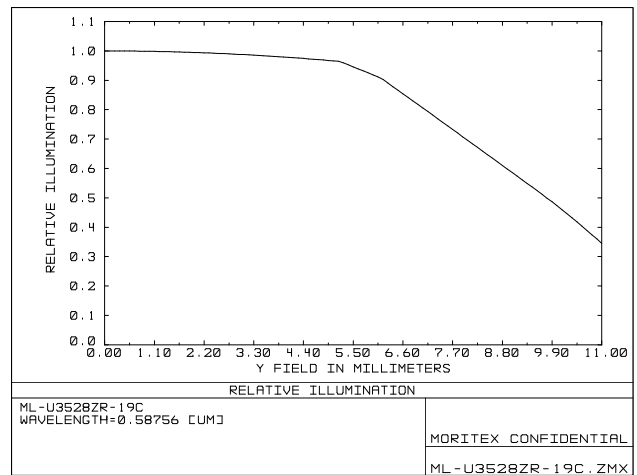
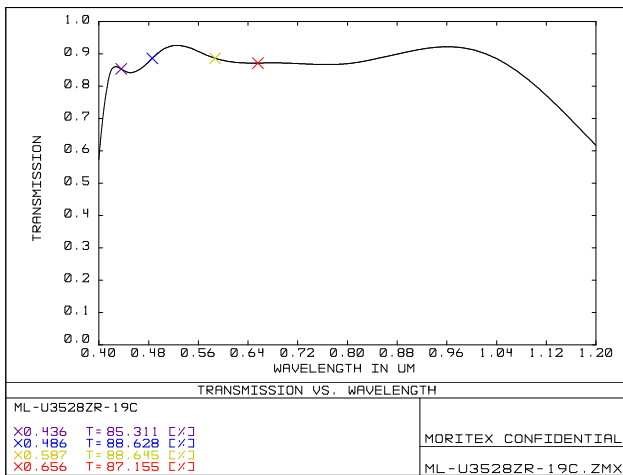
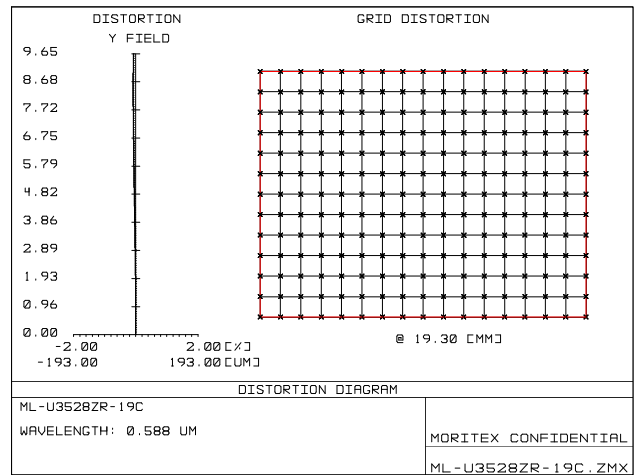
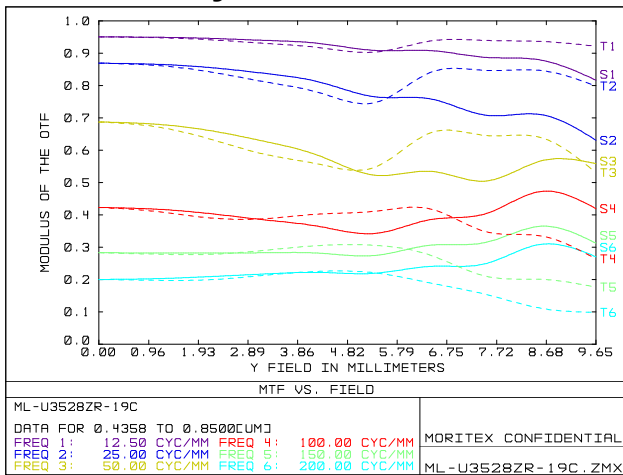

内容は、通知なしに随時変更されることがあります。

The content is subject to change at any time without notification.

株式会社 **モリテックス** MORITEX Corporation

Technology center Lens design & Development technology

moritex.mvs@moritex.com

www.moritex.com



WD=500.0mm Fno3.8

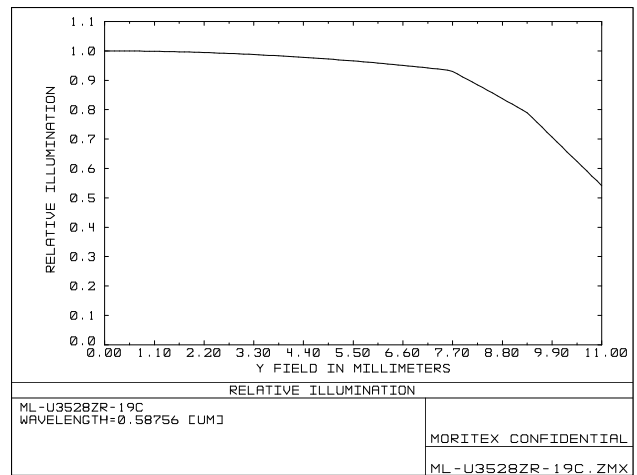
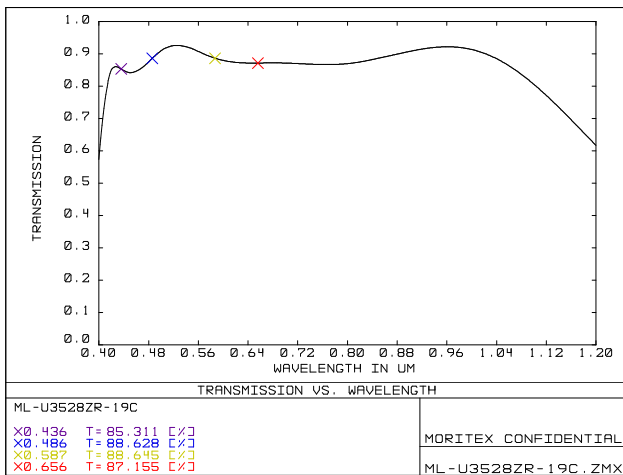
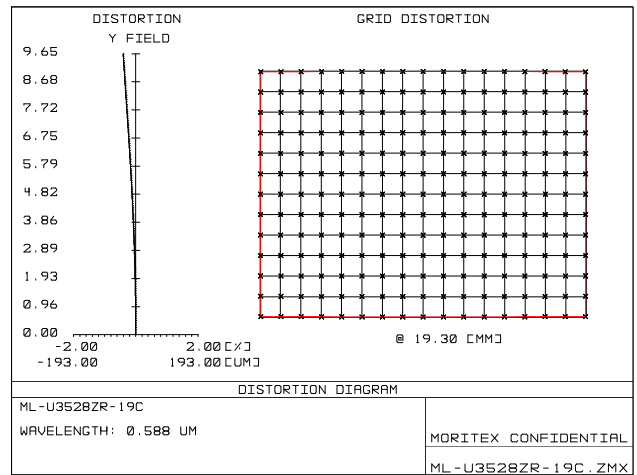
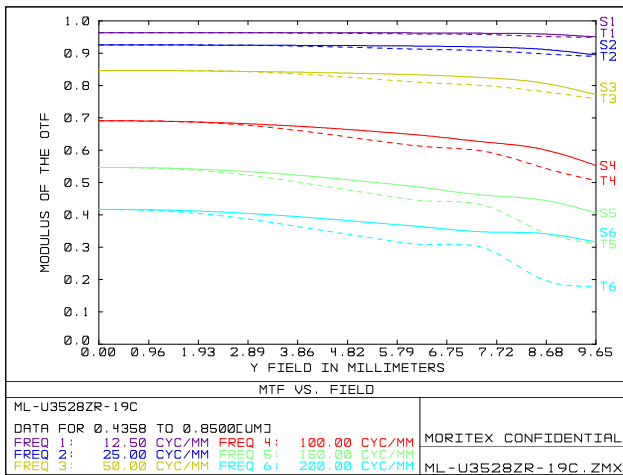

内容は、通知なしに随時変更されることがあります。

The content is subject to change at any time without notification.

株式会社 **モリテックス** MORITEX Corporation

Technology center Lens design & Development technology

moritex.mvs@moritex.com

www.moritex.com



WD=100.0mm Fno3.8

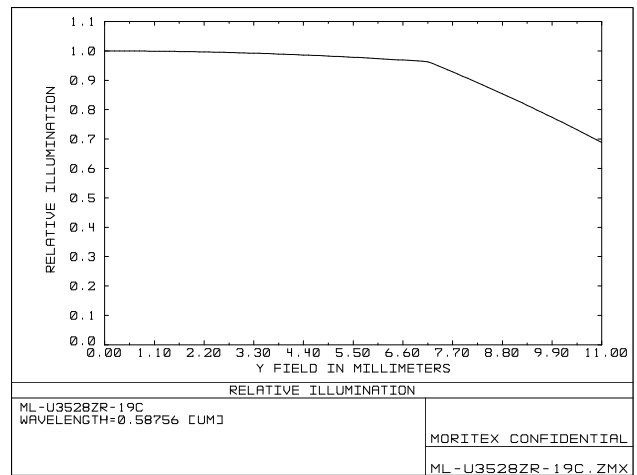
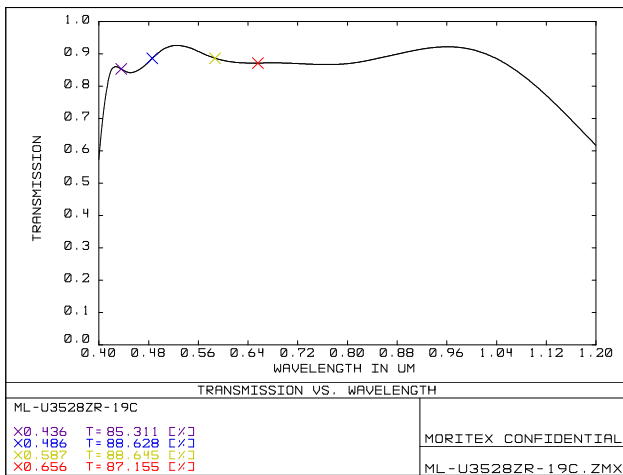
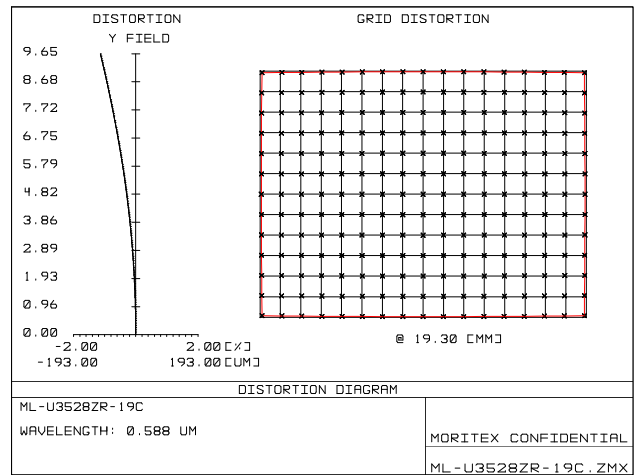
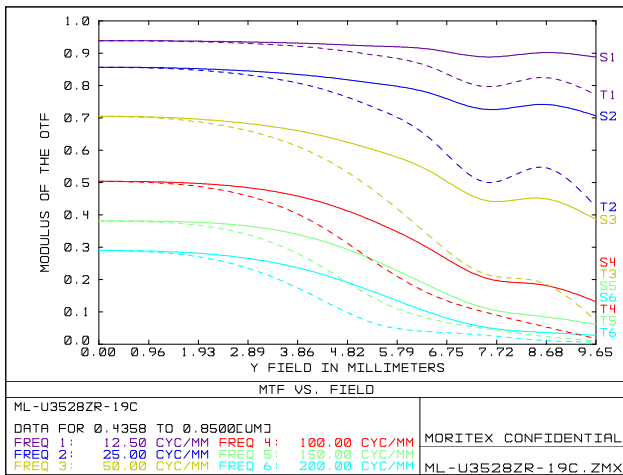

内容は、通知なしに随時変更されることがあります。

The content is subject to change at any time without notification.

株式会社 **モリテックス** MORITEX Corporation

Technology center Lens design & Development technology

moritex.mvs@moritex.com

www.moritex.com



WD=Infinity Fno3.8

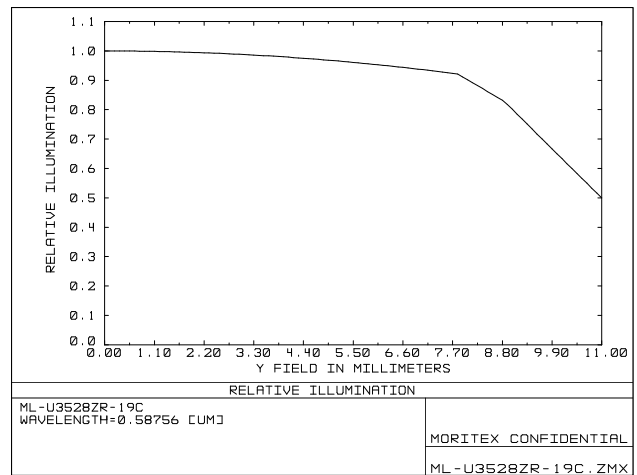
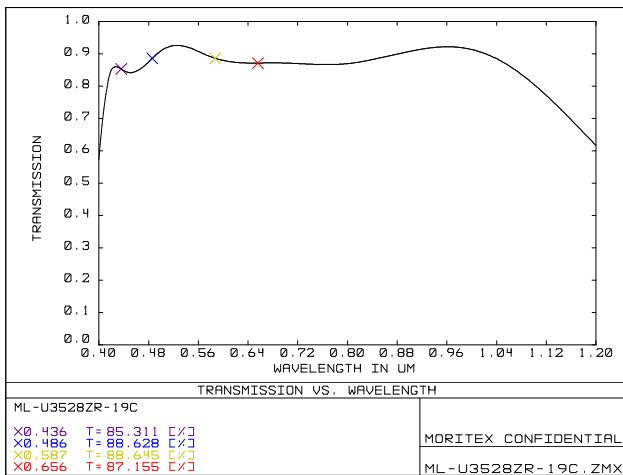
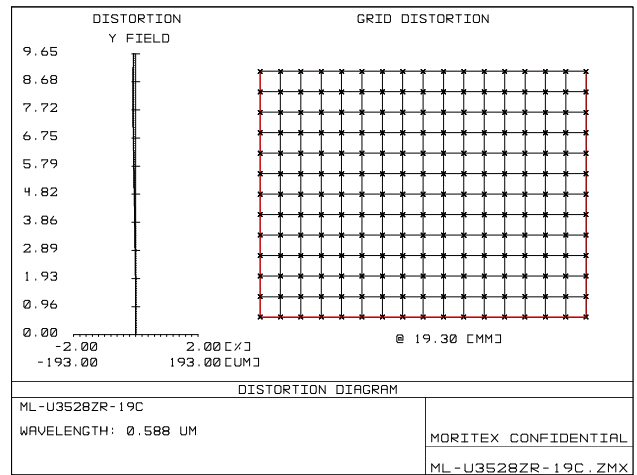
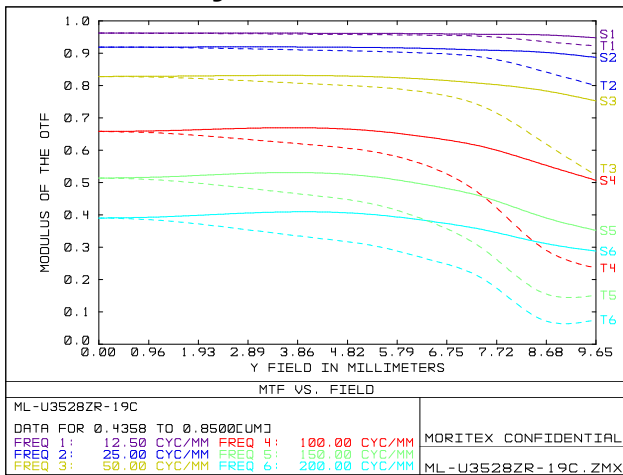

内容は、通知なしに随時変更されることがあります。

The content is subject to change at any time without notification.

株式会社 **モリテックス** MORITEX Corporation

Technology center Lens design & Development technology

moritex.mvs@moritex.com

www.moritex.com

